

# LED LINEAR HIGH BAY LIGHT

LL-2

Ultra-high efficiency  
up to 150 lm/W



Note: Not all of the products indicated in this specification are DLC premium listed, please refer to <https://www.designlights.org/searcher> for more details

**100W-322W**



UFO LIGHTING INC  
E-mail: [info@ufo-lighting.com](mailto:info@ufo-lighting.com) Web: [www.ufo-lighting.com](http://www.ufo-lighting.com)  
Add.: 503 Interchange Blvd Newark DE 19711 USA

Linear high-bay light is a device which are consist of aluminum alloy frame, LED light source model and driver. It can be a replacement of HID and other traditional light fixture, provided with higher efficacy, a longer lifetime 50,000H at least or even more up to 100,000H and very lower breakdown opportunity, higher reliability and better cost than any light before, and output voltage 60Vdc max means safety for use.

### Application:

- Indoor
- large industrial or commercial facility, public, logistics center etc
- IP54
- Working temperature:-40 to 50°C

### Electronic data

- Input voltage:100-277Vac,200-480Vac
- 6-10KV surge protection
- PF>90% and THD<10% (full loading)
- Free of flickering

### Dimming function

- Dimming function with 3 in1(0/1-10V,resistance and PWM)
- Optional for motion sensor
- Continuous dimming

### Optics feature

- CCT:2700K-6500K
- CRI:Ra80, R9 ≥0
- Light efficacy:150 lm/W
- Beam angle :120°
- UGR<28

### Others

- Chain installation
- Finishing: silvery
- 5 years warranty

## Technical Parameters

Model	Typical Wattage (W)	Input voltage (V)	Luminous (Lumen)	Efficacy (LM/W)	CCT (K)	Ra	Beam Angle	LED Chip	PF	IP	Dimension (L*W*H)
HG-LL02-100WBCD-EFGH-IJKLM	100	AC100-277V AC200-480V	15000	150	2700-6500	80	120°	3030/2835	0.97	IP54	430*320*31mm 16.9*12.6*1.2"
HG-LL02-120WBCD-EFGH-IJKLM	120	AC100-277V AC200-480V	18000	150	2700-6500	80	120°	3030/2835	0.97	IP54	430*320*31mm 16.9*12.6*1.2"
HG-LL02-150WBCD-EFGH-IJKLM	150	AC100-277V AC200-480V	22500	150	2700-6500	80	120°	3030/2835	0.97	IP54	580*320*31mm 22.8*12.6*1.2"
HG-LL02-162WBCD-EFGH-IJKLM	162	AC100-277V AC200-480V	24300	150	2700-6500	80	120°	3030/2835	0.97	IP54	580*320*31mm 22.8*12.6*1.2"
HG-LL02-200WBCD-EFGH-IJKLM	200	AC100-277V AC200-480V	30000	150	2700-6500	80	120°	3030/2835	0.97	IP54	1160*320*31mm 45.7*12.6*1.2"
HG-LL02-265WBCD-EFGH-IJKLM	265	AC100-277V AC200-480V	39750	150	2700-6500	80	120°	3030/2835	0.97	IP54	1160*320*31mm 45.7*12.6*1.2"
HG-LL02-322WBCD-EFGH-IJKLM	322	AC100-277V AC200-480V	48300	150	2700-6500	80	120°	3030/2835	0.97	IP54	1160*320*31mm 45.7*12.6*1.2"

## Model Nomenclature

Model: HG-LL02-ABCD-EFGH-IJKLM,For example:HG-LL02-150WL5D-50K8033-MSLAM

A	B	C	D	E	F	G	H	I	J	K	L	M
Rated Power	Input Voltage	Driver Brand	Dimming	CCT	CRI	LED Chip	Beam Angle	Dimension	Color	Installation	Lens	Sensor
100W 120W 150W 162W 200W 265W 322W	L-100~277V H-277~480V	Blank or 1-99	Blank-No Dimmable  D-Dimmable	30K-3000K 40K-4000K 50K-5000K	70-Ra70 80-Ra80 90-Ra90	1-99	1-60° 2-90° 3-120°	S-Small M-Medium L-Large	SL-Silvery WH-White	A-Chain	Blank-PC G-Glass	Blank-No sensor  M-Motion sensor



## Dimension

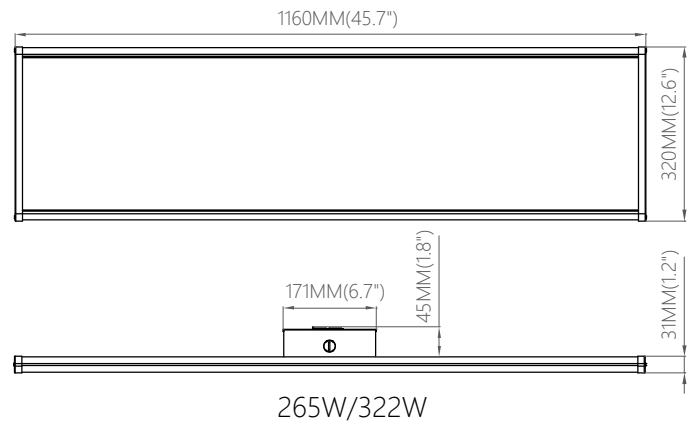
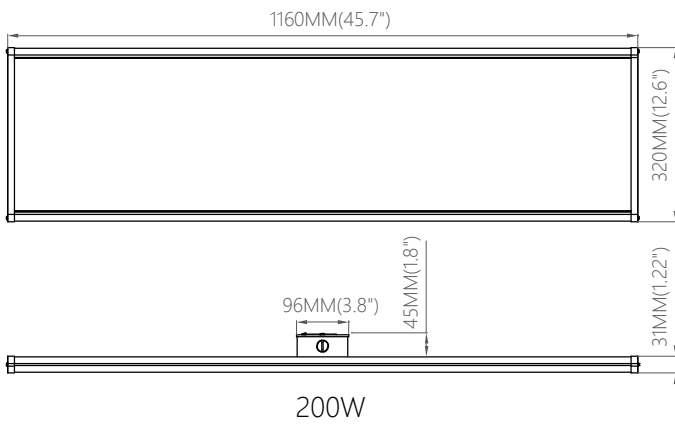
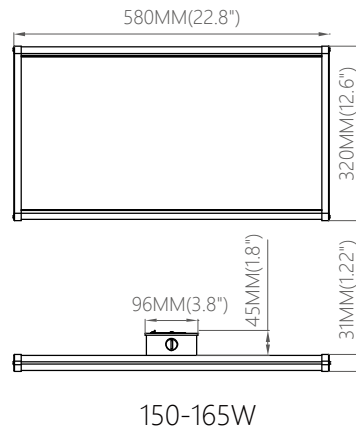
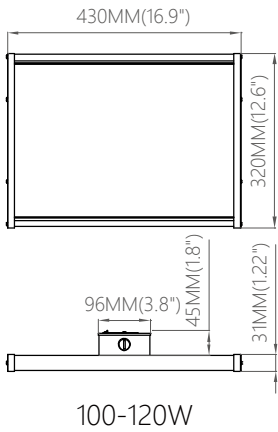

## Installation diagram

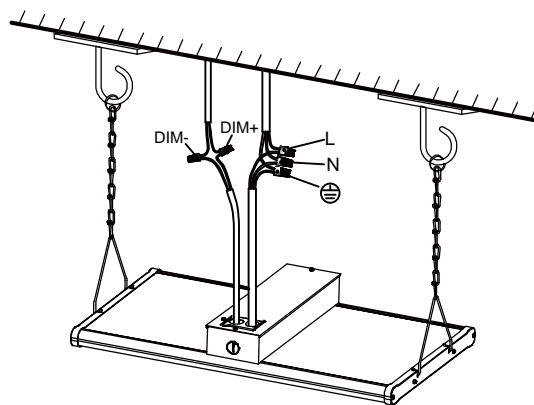

Chain



## Photometry

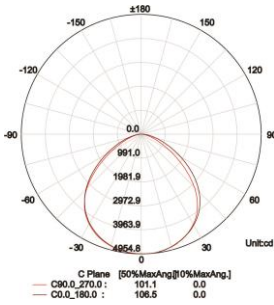

100W-120°

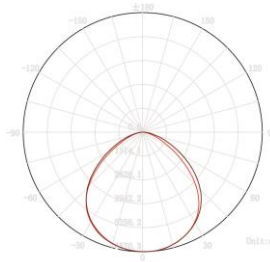
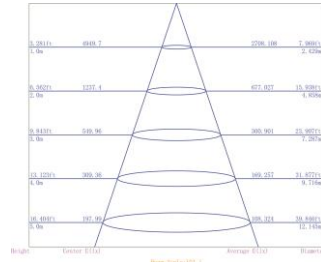

120W-120°

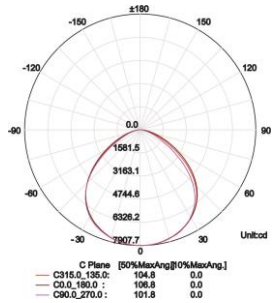
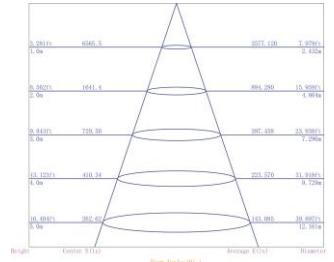

150W-120°

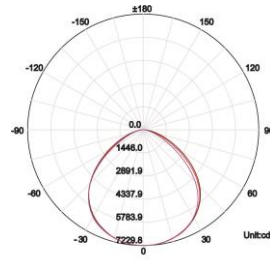
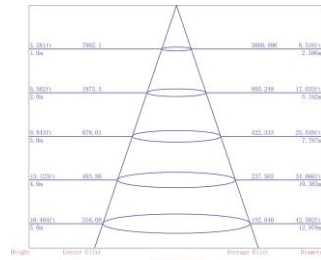

162W-120°

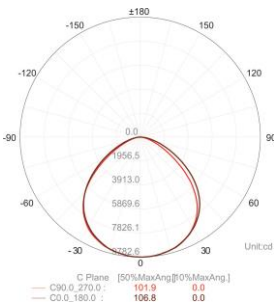
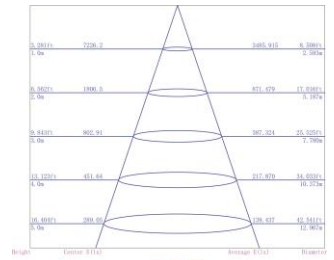

200W-120°

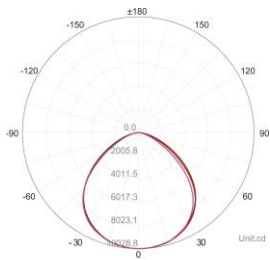
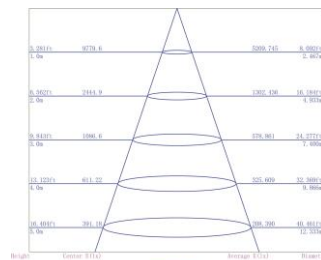

265W-120°

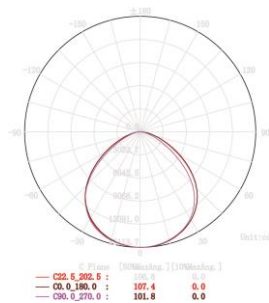
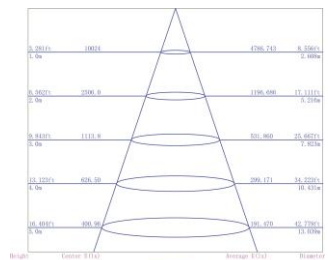

322W-120°

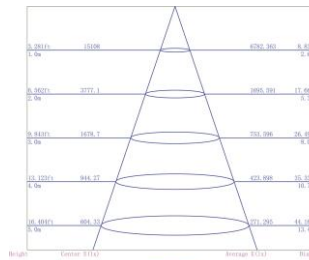

## Package

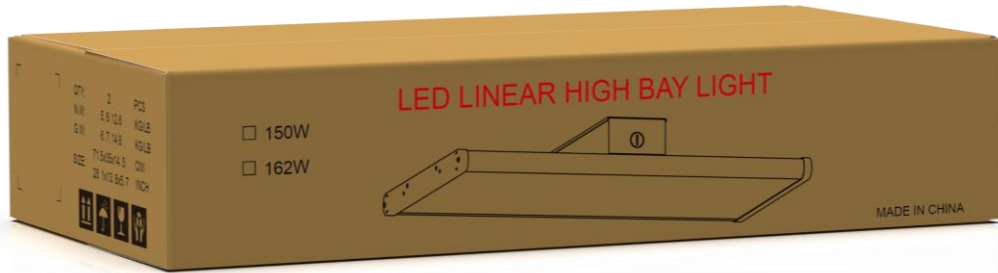

Type	Package			
Power	100W/120W	150W/162W	200W	265W/322W
Packing	Carton	Carton	Carton	Carton
Packing QTY	2PCS/CTN	2PCS/CTN	2PCS/CTN	2PCS/CTN
CTN SIZE	565*350*145mm 22.2*13.8*5.7inch	715*350*145mm 28.1*13.8*5.7inch	1295*350*145mm 51.0*13.8*5.7inch	1370*350*145mm 53.9*13.8*5.7inch
N.W.	4.8kg	5.8kg	9.6kg	11.6kg
G.W.	5.5kg	6.7kg	11kg	13.1kg
20GP (Inside Volume) 5690*2150*2180 mm	1800 pcs	1440 pcs	750 pcs	720 pcs
40GP (Inside Volume) 11800*2130*2180 mm	3720 pcs	2940 pcs	1620 pcs	1500 pcs
40HQ (Inside Volume) 11800*2130*2720 mm	4464 pcs	3528 pcs	1944 pcs	1800 pcs

